

Bring In the Fresh Air

Combustion Air System For DuraTech, DuraPlus HTC and PelletVent Pro

DuraVent's new, exclusive, patent-pending DuraPro Combustion Air System Wall Thimble and Ceiling Support Boxes is the ultimate solution for supplying outdoor air as combustion air for wood and pellet stoves.

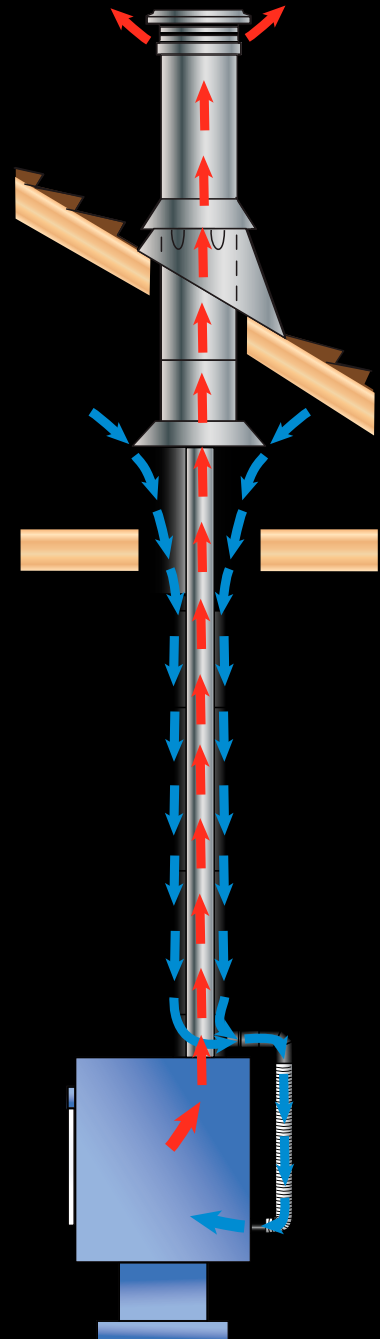

With the Combustion Air System

How it works:

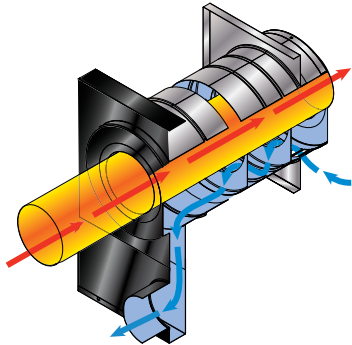

Wall Thimble

Outside air is drawn through the wall thimble's baffles, helping it pre-heat as it comes in contact with the hot inner exhaust pipe. The air continues down an air channel (pellet vent stoves), or an inner chamber of the combustion air stove pipe (wood stoves), through the aluminum flex and into the appliance, delivering fresh combustion air.

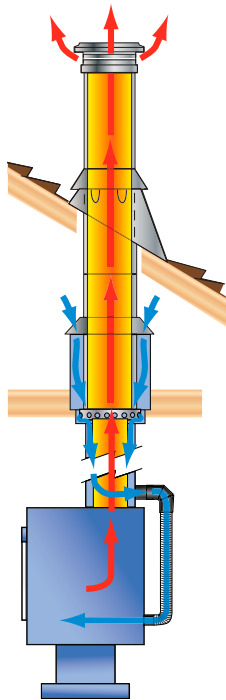

Ceiling Support Box

Fresh air is drawn and warmed through the top of the ceiling support box in the attic. The air continues down an inner chamber of the combustion air stove pipe, and stubs out at the top of the stove or tee. Aluminum flex completes the connection to the appliance.

The DuraPro Combustion Air System's (CAS) uniquely engineered ceiling support boxes and wall thimbles deliver combustion air to free-standing wood and pellet stoves.

DuraTech & DuraPlus HTC CAS wood stove systems are available in 6" and 8" chimney diameters, using system specific triple-wall connector pipe, elbows, and tees to deliver combustion air to the appliance from outside the room through the chimney penetration, eliminating the need for a separate penetration in the structure for combustion air intake.

The PelletVent Pro CAS stove system is available in 3" and 4" pellet chimney sizes. The system's pellet stove wall thimble is designed with an air channel to direct combustion air into the appliance. PelletVent Pro CAS is considered a direct vent for pellet appliances, which allows for clearances down to 12 inches to building openings, as defined by NFPA 211.

Eliminates the use of conditioned inside air for combustion.

Improve the efficiency of central heating systems by eliminating the use of conditioned room air for combustion.

Patent-pending design pre-heats combustion air.

Inbound air is circulated through baffles around the heated areas of the support box or wall thimble. For PelletVent Pro, the pre-heated air is delivered down a wall channel to assure that the pellet vent is not cooled. For DuraTech and HTC, the pre-heated air is supplied between the stove pipe's 2nd and 3rd wall, while the 1st wall maintains high stove temperatures.

Enables outside air to be used as combustion air below grade.

The wall thimbles for both wood and pellet stoves provide combustion air to appliances used in below grade (basement) installations. Wood stoves utilize the triple wall stove pipe. Pellet stoves utilize the adjustable air channel.

Minimizes down-drafts in below grade installations.

Does not consume warm indoor air for combustion and not subject to oxygen starvation, poor draft and other problems associated with 'tight' energy efficient homes.

Simplifies installations with only one wall or ceiling penetration.

The system is designed to eliminate the need for a second penetration in the building envelope to introduce combustion air.

Simple, elegant design with decorative black finish.

All products are factory finished in matte black.

Made in the USA.

Combustion Air System for DuraTech® and DuraPlus HTC®

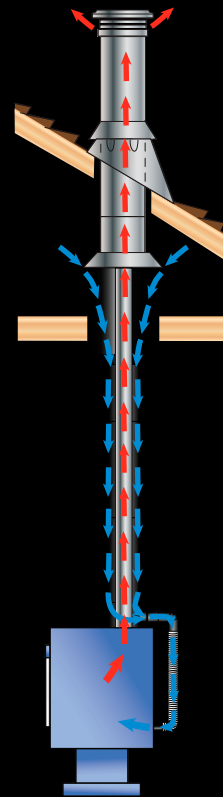

Vertical Installations

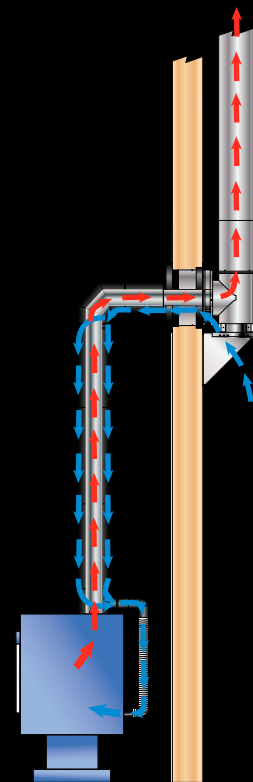

Horizontal Installations

NEW Combustion Air Wall Thimble

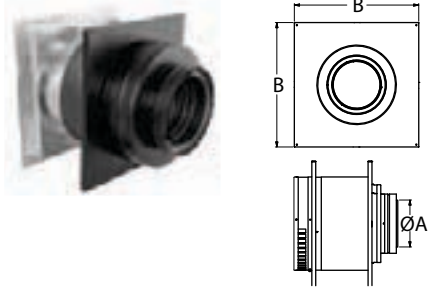

Provides connection between DuraTech or DuraPlus HTC chimney systems and the Combustion Air Stovepipe. Adjusts to fit wall thicknesses from 5 1/2" to 10". Extends into room 6". Patent-pending.

DURATECH				DURAPLUS HTC			
SIZE	STOCK #	A	B	SIZE	STOCK #	A	B
6"	6CAS-WTDT	6"	16"	6"	6CAS-WHTC	6"	16"
8"	8CAS-WTDT	8"	18"	8"	8CAS-WHTC	8"	18"

NEW Combustion Air Ceiling Support w/Collar

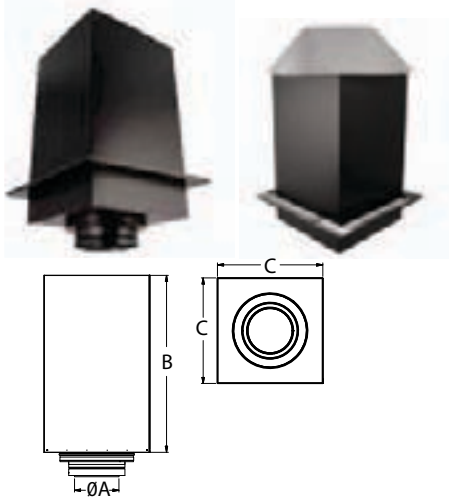

Provides connection between DuraTech or DuraPlus HTC chimney systems and the Combustion Air Stovepipe. Available in 24" or 36" heights, the Ceiling Support Box acts as an attic insulation shield with the addition of a Storm Collar. Ceiling Support extends a total of 7-1/2" below the ceiling. Black.

DURATECH					DURAPLUS HTC				
SIZE	A	B	C	STOCK #	SIZE	A	B	C	STOCK #
6"	06"	24"	14 5/16"	6CAS-CS24DT	6"	06"	24"	14 5/16"	6CAS-CS24HTC
6"	06"	36"	14 5/16"	6CAS-CS36DT	6"	06"	36"	14 5/16"	6CAS-CS36HTC
8"	08"	24"	14 5/16"	8CAS-CS24DT	8"	08"	24"	14 5/16"	8CAS-CS24HTC
8"	08"	36"	14 5/16"	8CAS-CS36DT	8"	08"	36"	14 5/16"	8CAS-CS36HTC

NEW Combustion Air Stovepipe



Used to connect the stove to either the DuraTech or DuraPlus HTC chimney systems. Exhaust gases are carried within the inner wall, and combustion air is conducted from the Support Box or Wall Thimble between the middle and outer walls. Available in 12" fixed lengths and three telescoping adjustable lengths (see below). Triple-wall. Black.

SIZE	A	STOCK #
6"	6"	6CAS-12
8"	8"	8CAS-12

NEW Combustion Air Adjustable Stovepipe

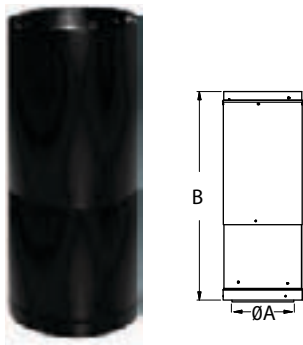

Used to connect the stove to either the DuraTech or DuraPlus HTC chimney systems. Exhaust gases are carried within the inner wall, and combustion air is conducted from the Support Box or Wall Thimble between the middle and outer walls. Available in three telescoping adjustable lengths: 14"-24", 29"-46", and 44"-68". Triple-wall. Black.

SIZE	A	B	STOCK #
6"	6"	14"-24"	6CAS-24A
6"	6"	29"-46"	6CAS-46A
6"	6"	44"-68"	6CAS-68A
8"	8"	14"-24"	6CAS-24A
8"	8"	29"-46"	6CAS-46A
8"	8"	44"-68"	6CAS-68A

NEW Combustion Air 45° Elbow

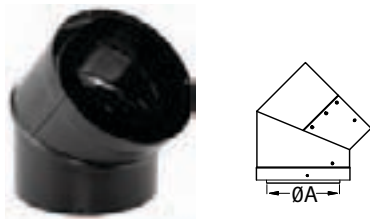

Use for the Combustion Air System stovepipe when an offset is needed.

SIZE	A	STOCK #
6"	6"	6CAS-E45
8"	8"	8CAS-E45

NEW Combustion Air Tee

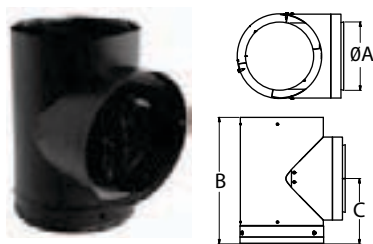

Use for the Combustion Air System stovepipe when attaching to rear-exit stoves.

SIZE	A	B	C	STOCK #
6"	6"	11 5/8"	6 5/8"	6CAS-T
8"	8"	14 1/2"	7 1/4"	8CAS-T

NEW Combustion Air
Stove Top Kit



Includes CAS Stovetop Adapter, 3" Aluminum Flex, 3" to 2" Decreaser, 3" single-wall Adjustable Elbow, & Hose Clamps.

SIZE	STOCK #
6"	6CAS-ADK
8"	8CAS-ADK

Combustion Air System for PelletVent Pro®

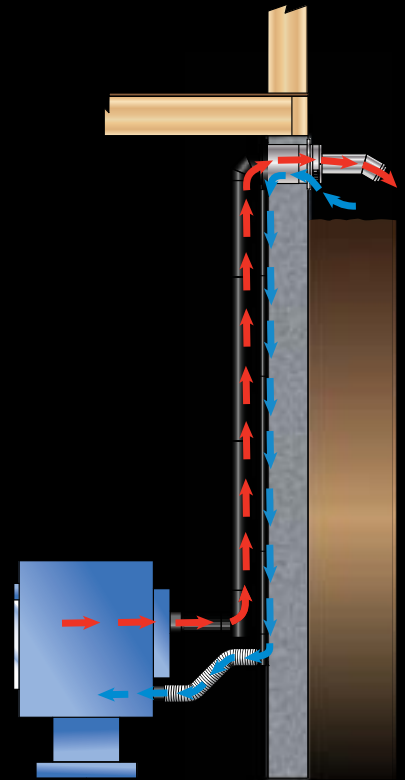

Below Grade Installations

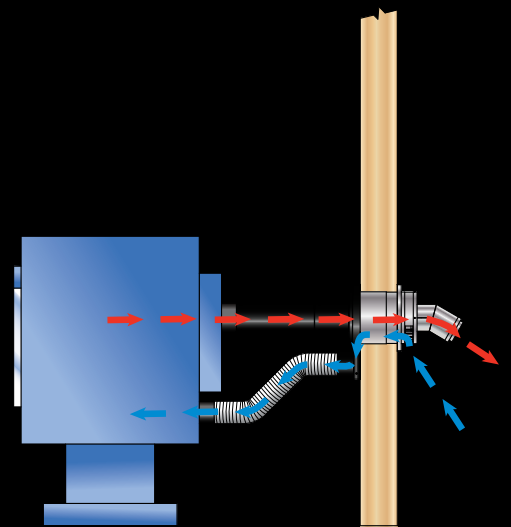

Horizontal Installations

NEW Combustion Air
Wall Thimble Kit

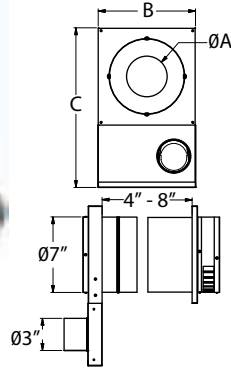

Includes Wall Thimble, Channel Adapter, Flex and 2" to A direct vent for bringing outside air for combustion through an adjustable air channel in wall thimble to appliance without cutting a second hole into the wall. Minimizes down drafts in below-grade installations. Patent-pending.

SIZE	STOCK #	A	B	C
3"	3CAS-WTPK	3 3/4"	9"	14 3/4"
4"	4CAS-WTPK	4 3/4"	9"	14 3/4"

NEW Combustion Air
Adjustable Wall Channel

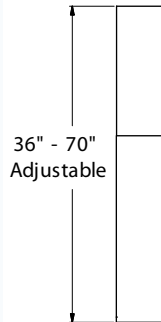

Telescoping Wall Channel 36"-70". Shown here attached to Combustion Air Wall Thimble Kit (not included).

SIZE	STOCK #
3" & 4"	CAS-C70A

FRESH AIR

COMBUSTION AIR SYSTEM FOR FREE-STANDING WOOD AND PELLET STOVES

DuraVent
Member of M&G Group

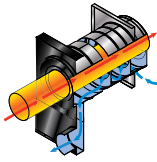

- Energy Efficient*
DuraVent's patent-pending Combustion Air System of Wall Thimbles and Ceiling Support Boxes that pre-heats combustion air from outside, eliminating the use of conditioned inside air.
- Minimizes down-drafts*
in below grade installations.
- Triple-Wall direct vent*
wood stove pipe system for DuraTech® & DuraPlusHTC®.
- Adjustable air channel*
delivers combustion air to pellet stoves with PelletVent Pro® system.
- Wall thimbles*
for both wood and pellet stoves provide outside air as combustion air to appliances in basements.
- Simplifies installations*
with only one wall or ceiling penetration.
- Decorative black finish*
for a simple, elegant design.

