

Installation and Maintenance Instructions

Model Saf-T Pipe

Heavy Duty Black Stove Pipe

(Also known as a Connector Pipe)

Single Wall Stove Pipe used to connect a Wood Burning Stove to a Listed Factory-Built Chimney System

IMPORTANT: A major cause of vent related fires is failure to maintain required clearances (air spaces) to combustible materials. It is of the utmost importance this Saf-T Pipe be installed only in accordance with these instructions.

Do not install this product until you have read and fully understand these installation instructions. Failure to install as described in these instructions may result in an injury or property damage, and may have an effect on your homeowner's insurance. An improper installation will void any stated warranty.

Keep these instructions in a safe place for future reference.

- Heavy-Duty Construction - 22 gauge
- Laser Welded Seams
- Beaded for Furnace Cement
- High-Temperature Low-Luster Finish

Saf-T Pipe is not a UL Listed Product



⚠ WARNING

Failure to follow the installation instructions could cause FIRE, CARBON MONOXIDE POISONING, OR DEATH. If you are unsure of installation requirements, call the phone number listed on the instructions, 1.800.433.6341 or visit www.selkirkcorp.com.

1000 Westinghouse Drive
Suite 1
New Stanton, PA 15672
www.northlineexpress.com

GENERAL

Model Saf-T Pipe is a single wall connector pipe which may be used to vent safety certified wood or coal fired appliances with a flue gas temperature not exceeding 1000° F. Saf-T Pipe is available in diameters of 5", 6", 7" and 8" and requires a 2" overlap. The installation must conform to applicable National, Regional, State and local building codes and NFPA 211, the standard for Chimneys, Fireplaces, Vents, and Solid Fuel-Burning Appliances. Contact the Authority Having Jurisdiction prior to beginning any work to obtain any required permits. Follow the appliance manufacturer's installation instructions carefully.

SAFETY

- Saf-T Pipe must be installed with a minimum of 18" clearance to any combustible surfaces or materials.
- Saf-T Pipe must not be enclosed or pass through a floor, ceiling, attic space, roof space, wall, closet, or any concealed space.
- To connect into an existing masonry chimney with a combustible wall, use the Listed Saf-T Thimble through-the-wall thimble/wall pass assembly to reduce the minimum 18 inch clearance to combustibles required by NFPA 211 Standard. (See separate instructions packaged with the Saf-T Thimble).
- For mobile home installations follow the installation instructions supplied with the mobile home appliance.

IMPORTANT

Read all instructions carefully before starting the installation. Failure to install Saf-T Pipe in accordance with these instructions will void the manufacturer's warranty.

Serious fire, health, or other safety hazards may result from any of the following:

- Installation of any damaged Saf-T Pipe;
- Unauthorized modification of any Saf-T Pipe components;
- Installation of any component part not manufactured or approved by Selkirk;

INSTALLATION GUIDELINES:

- Plan the installation of your appliance and Saf-T Pipe in such a way that your connector run is as short and straight as possible.
- Having an installation that is too long and / or with multiple bends, can reduce system draft which can affect the operation, and / or performance of your appliance and / or chimney system. Choose the proper diameter of connector pipe. It must be at least equivalent to the stove outlet diameter.
- Each Saf-T Pipe component will have a 2" overlap, take this into consideration when planning your installation.
- All joints between sections of Saf-T Pipe must be secured with four (4) sheet metal screws per joint before firing (supplied).
- Saf-T Pipe must be installed with the smallest diameter in the direction of the appliance, arranged so condensate will drain within the connector pipe and into the appliance (see Fig. 1);
- Saf-T Pipe must be sloped upward towards the chimney at least 1/4 inch per foot of horizontal run.

AVAILABLE COMPONENTS:

A variety of Saf-T Pipe components are available to complete a proper installation. These include:

- LENGTHS: 12", 18", 24", 36" and 48";
- ADJUSTABLE LENGTHS: 2" to 16" and 38" to 70";
- ELBOWS: 45°, 90° fixed and 90° adjustable;
- TEES;
- TEE COVER;
- CRIMPED TEE PLUG;
- INCREASER;
- REDUCER;
- WALL TRIM COLLAR;
- OVALIZED FLUE ADAPTERS FOR VERMONT CASTINGS STOVES

NOTE: Upon installing Saf-T Pipe, the black paint may be touched-up, as required, with ThurmaloX #270 black. When properly applied, this product is very effective in blending. Follow the instructions from the paint manufacturer for application.

LENGTHS (12", 18", 24", 36" and 48") :

A variety of lengths are available to make the connection from the appliance to the chimney easier without having to cut a pipe length (Fig. 1). These can be used vertically or horizontally. The crimped end (smaller diameter) is installed in the direction of the appliance.

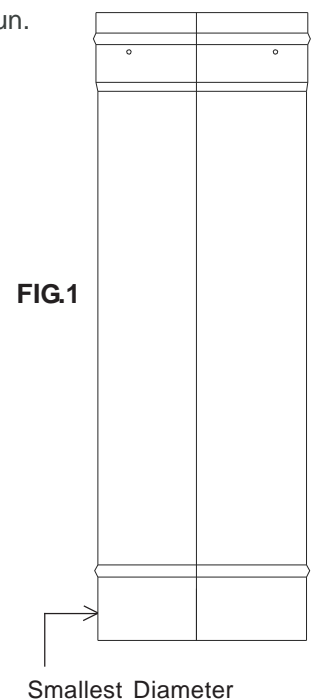

ADJUSTABLE LENGTHS (2" to 16" and 38" to 70"):

An Adjustable Length can be used vertically or horizontally allowing ease of removal for an inspection, maintenance or for cleaning.

Even if you have very carefully pre-planned, and pre-measured, very few installations work exactly using the fixed lengths of pipe available. Since the heavy gauge of Sat-T Pipe makes it difficult to cut (it is doable to cut off at the crimped end), we offer two (2) Adjustable Lengths, an 18" adjustable (2" to 16") and a 38" to 70" Adjustable Length.

Stand the two sections of adjustable pipes next to each other so that the top end of each pipe is the end with the pre-drilled screw holes (see Fig. 2).

Notice that the top of one pipe has the pre-drilled screw holes below the outward bead. This one will be Pipe #1.

The other pipe has the pre-drilled screw holes on the expanded portion of the pipe. This one will be Pipe #2. See Fig. 2.

Pipe #2 will slip into the top of Pipe #1. The end of Pipe #2 without the pre-drilled screw holes will slide down inside the top of Pipe #1. See Fig. 3.

When you have found the right installed length for your installation, use the pre-drilled screw holes in the top of Pipe #1 as a guide and drill through Pipe #2 using 1/8" drill bit. Secure the two lengths together by installing the 4 sheet metal screws provided.

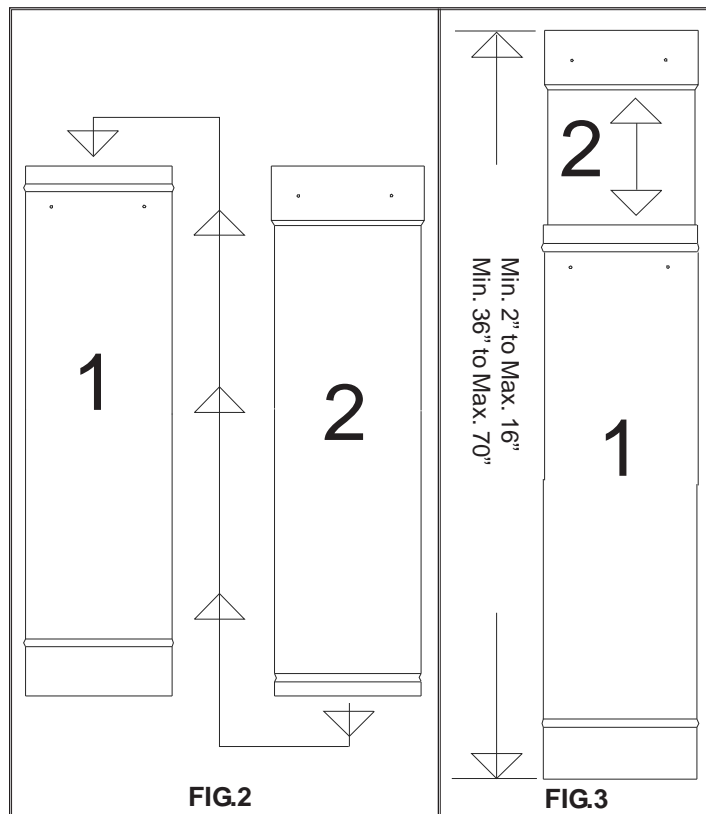

ELBOWS (45°, 90° and 90° Adjustable) :

Elbows allow a change in direction in the system or used as an offset when needed. Fixed elbows are available in a 45° or 90° and an adjustable elbow in a 90°. The crimped end is installed in the direction of the appliance. See Fig. 4.

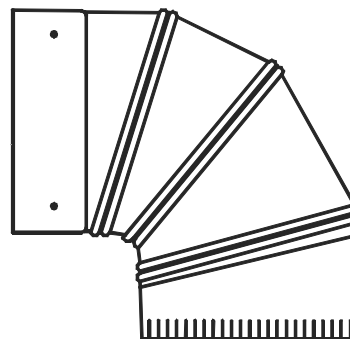

FIG.4

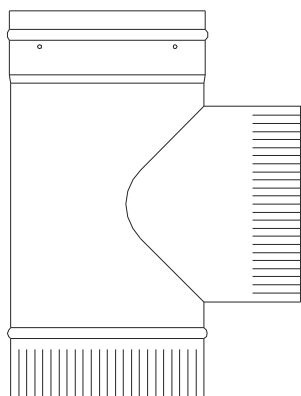

FIG.5

CRIMPED TEE :

Tees are used for a change in direction in the system and to facilitate the inspection and cleaning of the system. The crimped branch is installed in the direction of the appliance and a Tee Cover is used at the bottom of the Tee. See Fig. 5.

OTHER COMPONENTS :

Other Saf-T Pipe components are: Increases and Reducers (even though reducing is not recommended), Wall Trim Collar (when connecting to a masonry chimney) and Oval to Round Adapters (concentric and offset) to connect to Vermont Casting appliances. See Fig. 6.

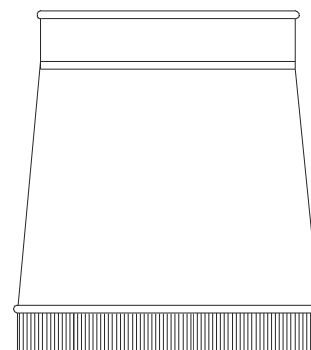
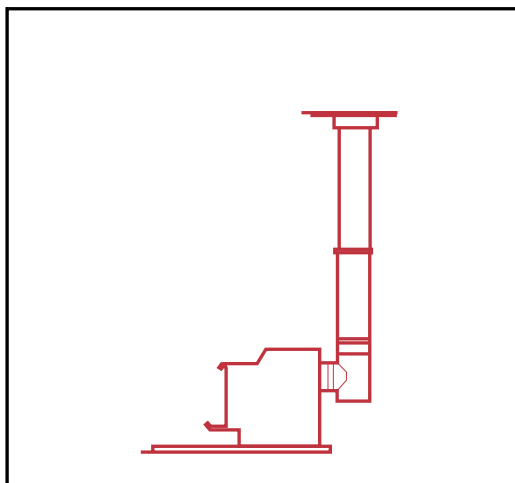
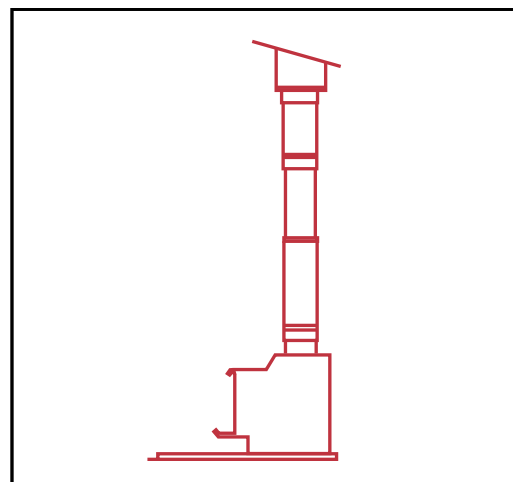
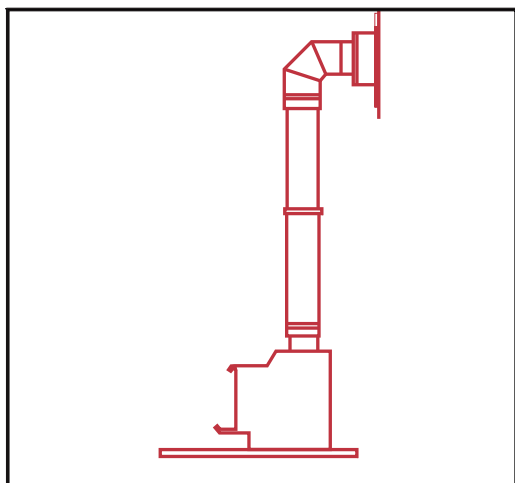

FIG.6

COMMON INSTALLATIONS:

The next 3 Figures show common installations, Saf-T Pipe connected in a flat ceiling application (Fig. 7), a vaulted ceiling application (Fig. 8) and an installation through an exterior wall (Fig. 9).

**FLAT CEILING - FIG.7****CATHEDRAL/SLOPED CEILING - FIG.8****EXTERIOR WALL - FIG.9****SAFE OPERATION AND MAINTENANCE :**

Do not use fuel materials corrosive to Saf-T Pipe such as driftwood, chemically treated wood or garbage or over fire your appliance. This could cause failure of the Saf-T Pipe and void any warranties. When wood is burned slowly, it produces tar and other organic vapors, which combine with expelled moisture to form creosote. The creosote vapors condense in the relatively cool chimney flue of a slow-burning fire. As a result, creosote residue accumulates on the flue lining. When ignited, this creosote makes an extremely hot fire. Consult your local Extension Service or other authority to learn how to properly burn seasoned wood as a heat source.

With a new installation, the system should be inspected frequently (every 2 weeks if need be) to determine the rate of creosote formation. When familiar with the appliance and its venting system characteristics, the system should be inspected at least once every 2 months during the heating season to determine if a creosote or soot build-up has occurred.

If you see deposits clean all connector pipe and the chimney system mechanically (with a properly sized plastic cleaning brush) to reduce the risk of a chimney fire. Inspect your Saf-T Pipe for any damage before the start of the season. Replace any damaged parts.

KEEP YOUR CHIMNEY AND SAF-T PIPE CLEAN!

“SMART CHOICE” LIMITED LIFETIME WARRANTY

Selkirk Corporation, (“Selkirk”, “we”, “us”, “our”) warrants our residential Chimney & Venting products (* defined below) to be free from defects in material and workmanship. For products installed after January 1, 2009, for a period of Ten (10) years from original installation, we will provide replacement product with a similar or like quality of available Selkirk product, **free of charge**, excluding any installation costs. From the Eleventh (11) through Fifteenth (15) years, we will provide replacement product at a cost of 75% off the published Retail Price in effect on the date the claim is received, excluding any installation costs. At expiration of the Fifteen (15) year term, we will provide replacement product at a cost of 50% off the published Retail Price in effect on the date the claim is received excluding any installation costs. This warranty coverage is non-transferable and applies exclusively to the original consumer.

PROFESSIONAL INSTALLATION:

If installation is performed by Professional Installers certified in Canada by WETT or APC or in the USA by NFI or CSIA, we will provide replacement product with a similar or like quality of available product, free of charge (excluding any installation costs) for the full Fifteen (15) years from the date of original installation. To be eligible for this additional warranty the consumer must provide a proof of installation by a Professional Installer when submitting a claim.

LIMITATIONS:

BUYER'S REMEDIES ARE LIMITED TO REPAIR OR REPLACEMENT OF THE PRODUCT AND DO NOT INCLUDE INSTALLATION COSTS. EXCEPT AS SET FORTH HEREIN, ALL OTHER WARRANTIES (EXPRESS OR IMPLIED, INCLUDING THE WARRANTIES OF MERCHANTABILITY AND FITNESS FOR A PARTICULAR PURPOSE) ARE HEREBY DISCLAIMED. IT IS AGREED THAT THIS SHALL BE THE SOLE AND EXCLUSIVE REMEDY OF THE BUYER. IN NO EVENT SHALL WE BE LIABLE FOR ANY CONSEQUENTIAL, SPECIAL OR PUNITIVE DAMAGES ARISING DIRECTLY OR INDIRECTLY FROM THE USE OF THE PRODUCTS WHETHER BASED ON WARRANTY, CONTRACT NEGLIGENCE OR STRICT LIABILITY.

ALL LENGTHS, TEES, ELBOWS, AND COMPONENTS SUPPLIED BY US ARE SUBJECT TO WARRANTY COVERAGE. PRODUCT SUPPLIED BY US AS REPLACEMENT FOR ORIGINAL MATERIAL WILL BE SUBJECT TO A ONE-YEAR WARRANTY COVERAGE WITH THE EXCEPTION OF SAF-T PIPE WHICH IS SUBJECTED TO A 5 YEAR LIMITED WARRANTY COVERAGE FROM DEFECTS IN MATERIAL OR WORKMANSHIP WHEN PROPERLY INSTALLED PURSUANT TO THE MANUFACTURER'S INSTALLATION INSTRUCTIONS AND APPROPRIATE CODES.

WARNING: FAILURE TO INSTALL OR OPERATE PRODUCTS ACCORDING TO THE MANUFACTURER'S INSTRUCTIONS, OR FAILURE TO USE PRODUCTS WITH RESIDENTIAL APPLIANCES THAT HAVE BEEN CERTIFIED AT AN ACCREDITED LABORATORY WILL VOID ALL APPLICABLE WARRANTIES.

THIS WARRANTY DOES NOT COVER:

- (a) any non-stainless base tee unit mounted or connected to an Insulated Chimney system;
- (b) costs (labor or otherwise **) associated with either removing a previously installed product, installing a replacement product, transportation or return of a product, or transportation of replacement product;
- (c) damage to the finish of products caused by the use of improper solvents/chemicals or improper (or lack of) cleaning methods;
- (d) damage resulting from normal wear and tear or failure to reasonably clean, care for or maintain products in accordance with our installation instructions/recommendations;
- (e) damage (to products, appliances or structure) based on or resulting from improper installation or repair, misuse or abuse (including, but not limited to, excessive or improper operating condition), or alteration or adjustment other than in conformity with our installation instructions and specifications, whether performed by a contractor, service company, technician, or yourself;
- (f) any products that have been moved from their original installation site;
- (g) damage caused by burning driftwood, garbage, or any other prohibitive material that has been burned in the appliance served by the chimney;
- (h) damage that results from accidents such as fire, flood, high winds, “acts of God”, or any other contingency beyond our control.

** Due to the wide variance in installation practices and other conditions beyond our control, except as stated above, we do not guaranty or in any way warrant the installation of Chimney and Venting products.

CLAIM PROCEDURE: If you believe that a product is defective, notify us in writing at:

SELKIRK CORPORATION

5030 Corporate Exchange Blvd.,
Grand Rapids, MI 49512
ATTN: WARRANTY CLAIMS
1.800.433.6341
www.selkirkcorp.com

SELKIRK CANADA

P. O. Box 526, Depot 1,
Hamilton, Ontario, CANADA, L8L 7X6
ATTN: WARRANTY CLAIMS
1.888.735.5475
www.selkirkcorp.com

Notification should include a description of the product, model and serial number (if applicable) and a description of the product defect. Upon receipt of a written claim under this limited warranty and evidence of the date of purchase or installation, at our option and in our sole discretion, we will provide replacement product with similar or like quality of available product excluding any installation costs. We reserve the right to inspect or investigate any warranty claims prior to determining whether to provide replacement product. If, as determined by us, that repair or replacement of the product is not commercially practicable or cannot be completed in a timely manner, we may refund the prorated purchase price paid for the product upon verification by providing a copy of your invoice or receipt of bill of sale.

*Selkirk products covered under this warranty: AFCL, ALT, BV (SD, MD, LD), DFS, DSP, DT, DWC/SWC, E, FC (JSC), GT, GTL, PL, QC, R, RF, RV, SAF-T LINER, SAF-T PIPE, SC (JM), SFCL, SPR, ST, U1, UPP, UT, UTL, VP, WV.